







A		5
B		1
C		1
D		1
E		1
F		1
G		1
H		1

1

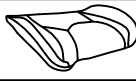

2

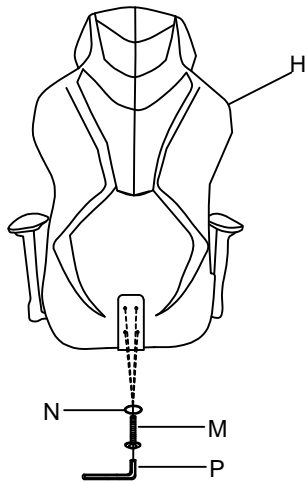
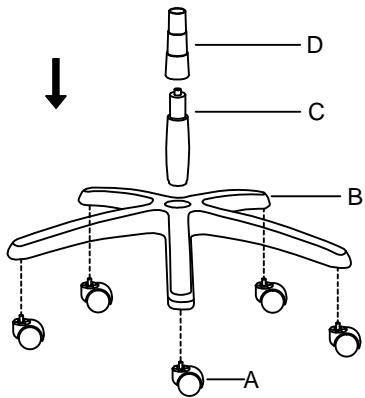



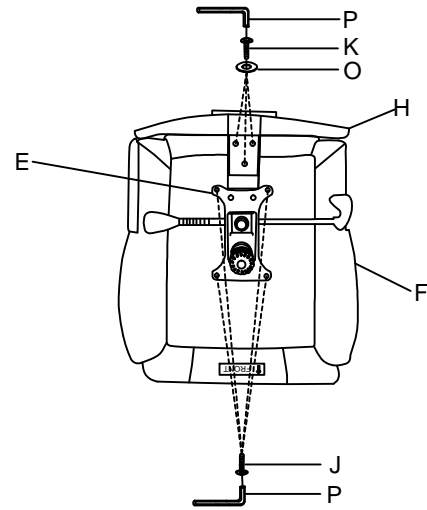



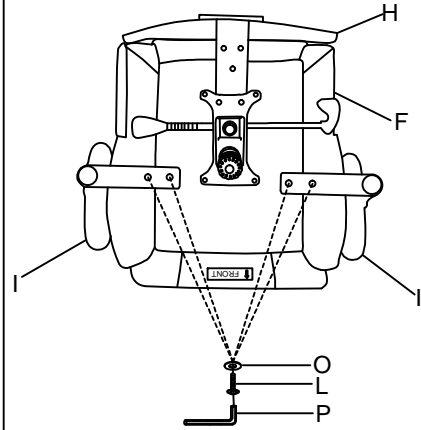

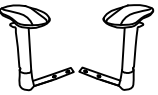
3



4

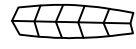

I		1
J		4
K		3
L		4
M		4
N		4
O		7
P		1
Q		1

5

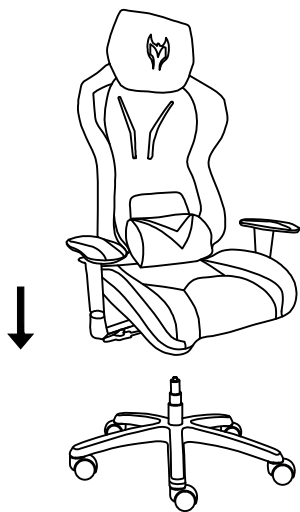

6

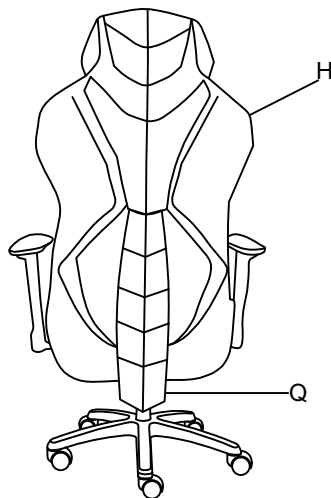

7

